

PROPRIETARY RIGHTS ARE CLAIMED FOR THE MATERIAL DISCLOSED IN THIS DRAWING.

TYP. WALL THICKNESS = 1.8

LTR.	REVISIONS	DATE
✂	*****	00-00-98

SEAL OPTIONS  
SEAL THICKNESS = .8

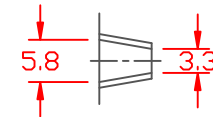
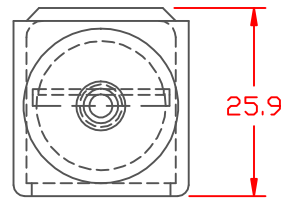
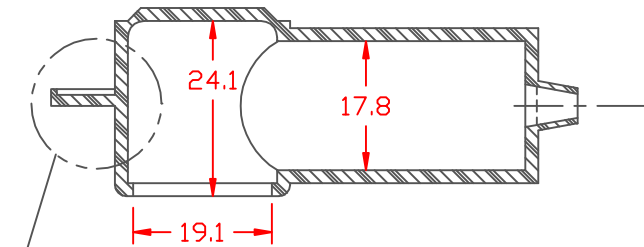

NO. 1  
Wire Gages  
18 - 10

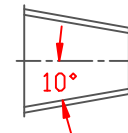

NO. 2  
Cable Gages  
8 - 2

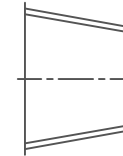

NO. 3  
Cable Gages  
2 - 2/0

SEE VIEW "B"

SECTION A-A

SEAL NO. 1 SHOWN

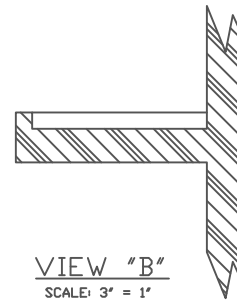
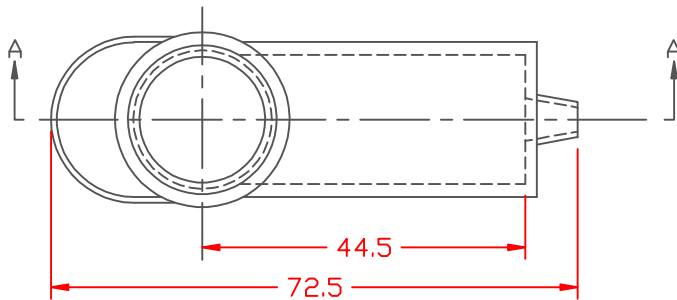

VIEW "B"  
SCALE: 3" = 1"

TOLERANCE UNLESS OTHERWISE SPECIFIED: ±.030"/±0.8mm  
RADIAL DIAMETERS TO BE MEASURED OVER MANDRELS,  
RING GAGES OR PIN GAGES OF SUITABLE SIZE

VTE Material Part No:	1101650102
Material:	RED PVC
Material Part No:	9812-65-RED683
Max. Operating Temp:	105 C
Shore Durometer:	"A" 10 SEC. 67/62
Specific Gravity:	1.34
Ult. Elongation %:	475
Brittle Temp:	-44 C
Tensile Strength PSI:	1547 PSI
Dielectric Strength, v./ml:	540
U.L. Rating:	94 V2
MEETS:	FMVSS.302

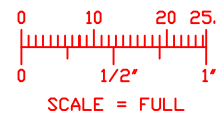

		<b>VTE Incorporated</b> 5437 Robinson Road, P.O. Box 790 Pellston, Michigan 49769 Telephone: 1-800-527-9256, 231-539-8000 FAX: 231-539-0914	
		REF:	DATE:
	3-20-98	JC	.024 LBS. / 10.8 G.
TITLE: TERMINAL INSULATOR CAP		PART NO.	
MATERIAL:		220E1V02	
COLOR:	DRG CLASS		