

PROPRIETARY RIGHTS ARE CLAIMED FOR THE MATERIAL DISCLOSED IN THIS DRAWING.

TYP. WALL THICKNESS = 1.8

LTR.	REVISIONS	DATE
✳	*****	00-00-98

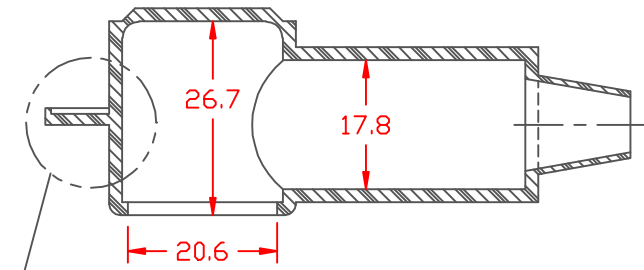

SEE VIEW "B"

SECTION A-A

SEAL NO. 2 SHOWN

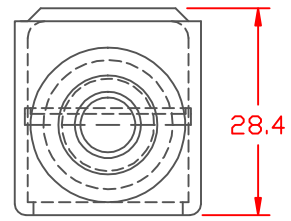

SEAL OPTIONS
SEAL THICKNESS = .8

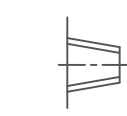

NO. 1
Wire Gages
18 - 10

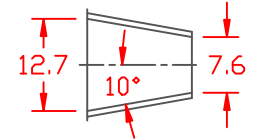

NO. 2
Cable Gages
8 - 2

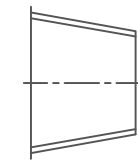

NO. 3
Cable Gages
2 - 2/0

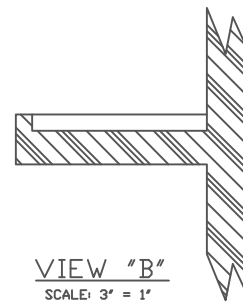
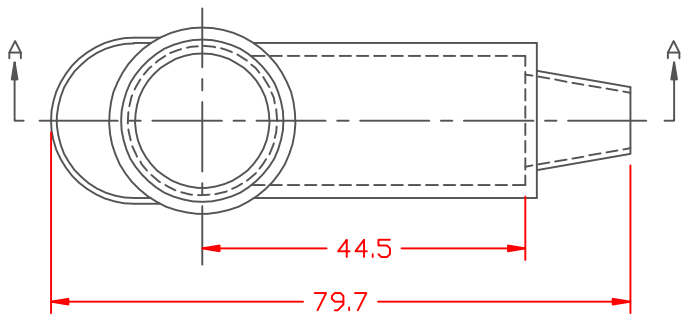

VIEW "B"
SCALE: 3" = 1"

TOLERANCE UNLESS OTHERWISE SPECIFIED: ±.030"/±0.8mm
RADIAL DIAMETERS TO BE MEASURED OVER MANDRELS,
RING GAGES OR PIN GAGES OF SUITABLE SIZE

VTE Material Part No:	1101650102
Material:	RED PVC
Material Part No:	9812-65-RED683
Max. Operating Temp:	105 C
Shore Durometer:	"A" 10 SEC. 67/62
Specific Gravity:	1.34
Ult. Elongation %:	475
Brittle Temp:	-44 C
Tensile Strength PSI:	1547 PSI
Dielectric Strength, v./ml:	540
U.L. Rating:	94 V2
MEETS:	FMVSS.302

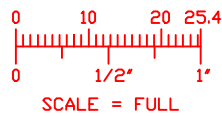

VTE Incorporated
5437 Robinson Road, P.O. Box 790
Pellston, Michigan 49769
Telephone: 1-800-527-9256, 231-539-8000
FAX: 231-539-0914

REF:	DATE: 3-24-98	DRN BY: JC	WEIGHT: .025 LBS. / 11.5 G.
TITLE: TERMINAL INSULATOR CAP		CHK'D BY:	
MATERIAL:		PART NO. 222E2V02	
COLOR:	DRG CLASS		