

PROPRIETARY RIGHTS ARE CLAIMED FOR THE MATERIAL DISCLOSED IN THIS DRAWING.

TYP. WALL THICKNESS = 2.0

LTR.	REVISIONS	DATE
✧	*****	00-00-98

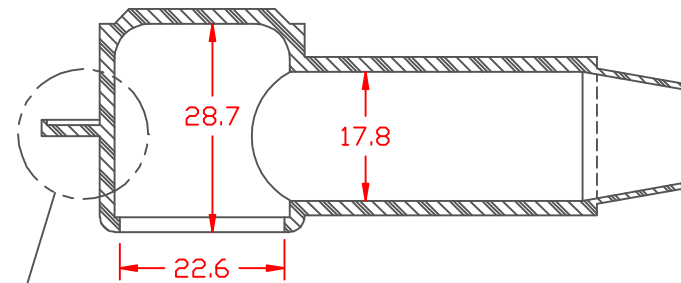

SECTION A-A

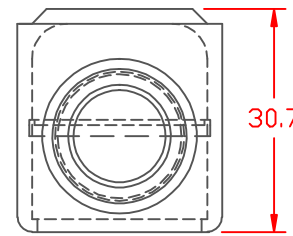

SEAL NO. 3 SHOWN

SEAL OPTIONS

SEAL THICKNESS = .8



NO. 1
Wire Gages
18 - 10

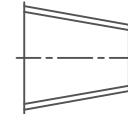

NO. 2
Cable Gages
8 - 2

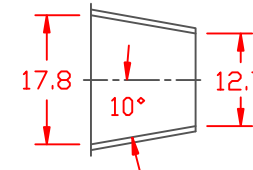

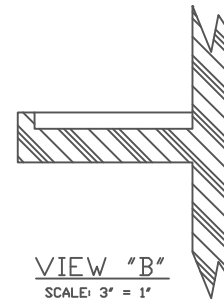
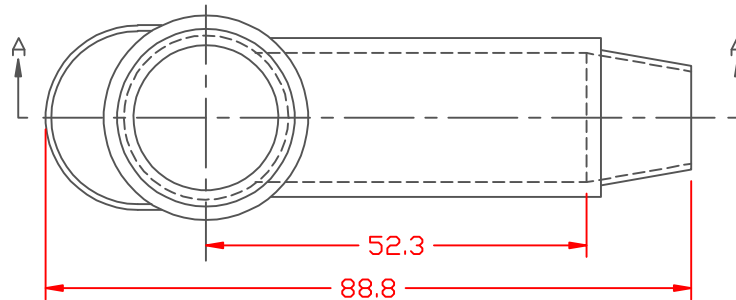

NO. 3
Cable Gages
2 - 2/0

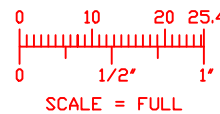

TOLERANCE UNLESS OTHERWISE SPECIFIED: ±.030"/±0.8mm
RADIAL DIAMETERS TO BE MEASURED OVER MANDRELS,
RING GAGES OR PIN GAGES OF SUITABLE SIZE

VTE Material Part No:	1101650102
Material:	RED PVC
Material Part No:	9812-65-RED683
Max. Operating Temp:	105 C
Shore Durometer:	"A" 10 SEC. 67/62
Specific Gravity:	1.34
Ult. Elongation %:	475
Brittle Temp:	-44 C
Tensile Strength PSI:	1547 PSI
Dielectric Strength, v./ml:	540
U.L. Rating:	94 V2
MEETS:	FMVSS.302



		VTE Incorporated 5437 Robinson Road, P.O. Box 790 Pellston, Michigan 49769 Telephone: 1-800-527-9256, 231-539-8000 FAX: 231-539-0914	
		REF:	DATE:
	3-24-98	CHK'D BY:	.035 LBS. / 15.9 G.
TITLE: TERMINAL INSULATOR CAP			
MATERIAL:		PART NO.	
		224E3V02	
COLOR:	DRG CLASS		